

...you'll never drive alone



MAN

suitable for

QTC® QUALITY
TRUCK
COMPONENTS

EDITION 2019

TGX 2013

TGS 2013

TGX 2007 - 2012

TGS 2007 - 2012

TGA XL-XXL

TGA M-L-LX

F2000

TGL

LE2000

page 3

page 5

page 7

page 9

page 10

page 16

page 18

page 23

page 24

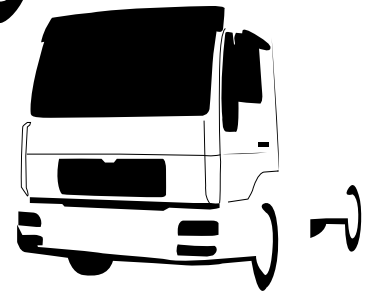

SUITABLE FOR **MAN TGX 2013**



M6X/106 RH



M6X/106G RH

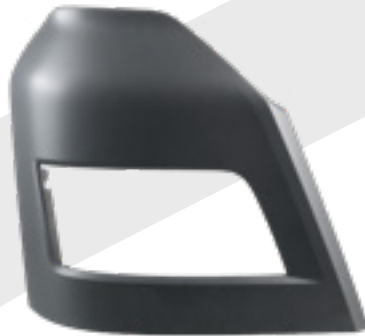

M6X/107G LH



M6X/107 LH



M6X/102 RH



M6X/102G RH



M6X/103G LH



M6X/103 LH



SUITABLE FOR **MAN TGX 2013**



M6X/104 RH



M6X/104G RH

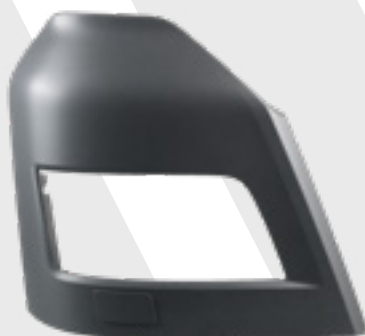

M6X/105G LH



M6X/105 LH



M6X/122 KIT

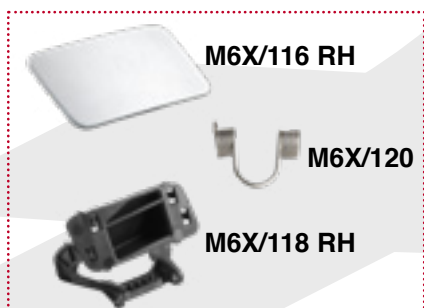

M6X/122G KIT

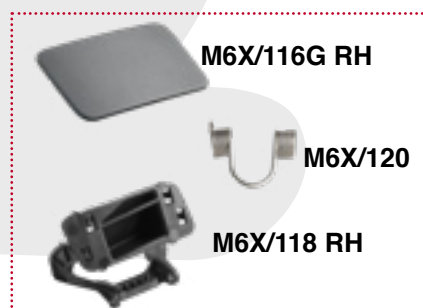

M6X/123G KIT



M6X/123 KIT



SUITABLE FOR **MAN TGS 2013**



M6S/106 RH

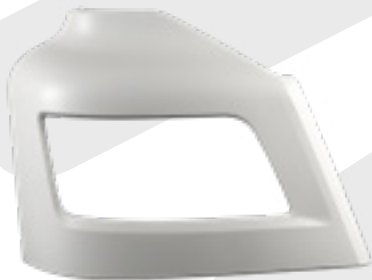

M6S/106G RH



M6S/107G LH



M6S/107 LH



M6S/102 RH



M6S/102G RH



M6S/103G LH



M6S/103 LH

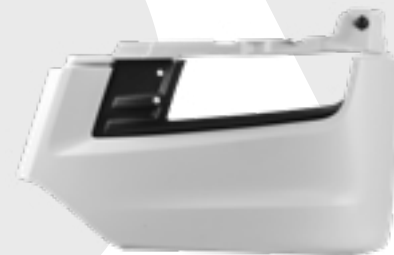

SUITABLE FOR **MAN TGS 2013**



M6S/104 RH



M6S/104G RH



M6S/105G LH

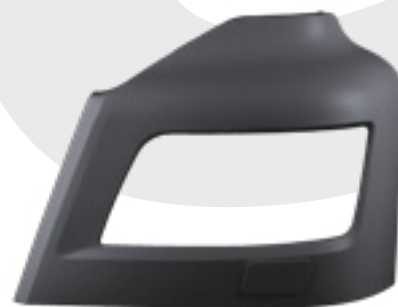

M6S/105 LH



M6X/122 KIT

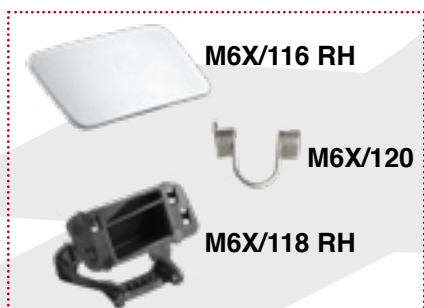

M6X/122G KIT

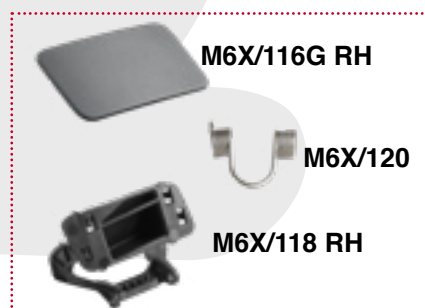

M6X/123G KIT



M6X/123 KIT



SUITABLE FOR **MAN TGX 2007 - 2012**



MTX/180 GREY
MTX/180K KIT



MTX/710 RH



MTX/100K kit

MTX/100

MTX/116 RH



MTX/115 LH



MTX/711 LH



MTX/706 RH
MTX/706X RH (XENON)



MTX/707 LH
MTX/707X LH (XENON)



MTX/722 RH



MXX/183



MXX/183



MTX/723 LH



MTX/182 RH



MTX/181 LH



SUITABLE FOR **MAN TGX** 2007 - 2012



MTX/300 RH



MTX/301 LH



MTX/311 RH - LH



MTX/304 RH



MTX/305 LH



MTX/309 RH - LH



SUITABLE FOR **MAN TGS** 2007 - 2012



MTS/350 RH *



MXX/356



MTS/351 LH *



MTS/182 RH



MTS/181 LH



*** MXX/356 INCLUDED**

SUITABLE FOR MAN TGA XL - XXL 2002 - 2007

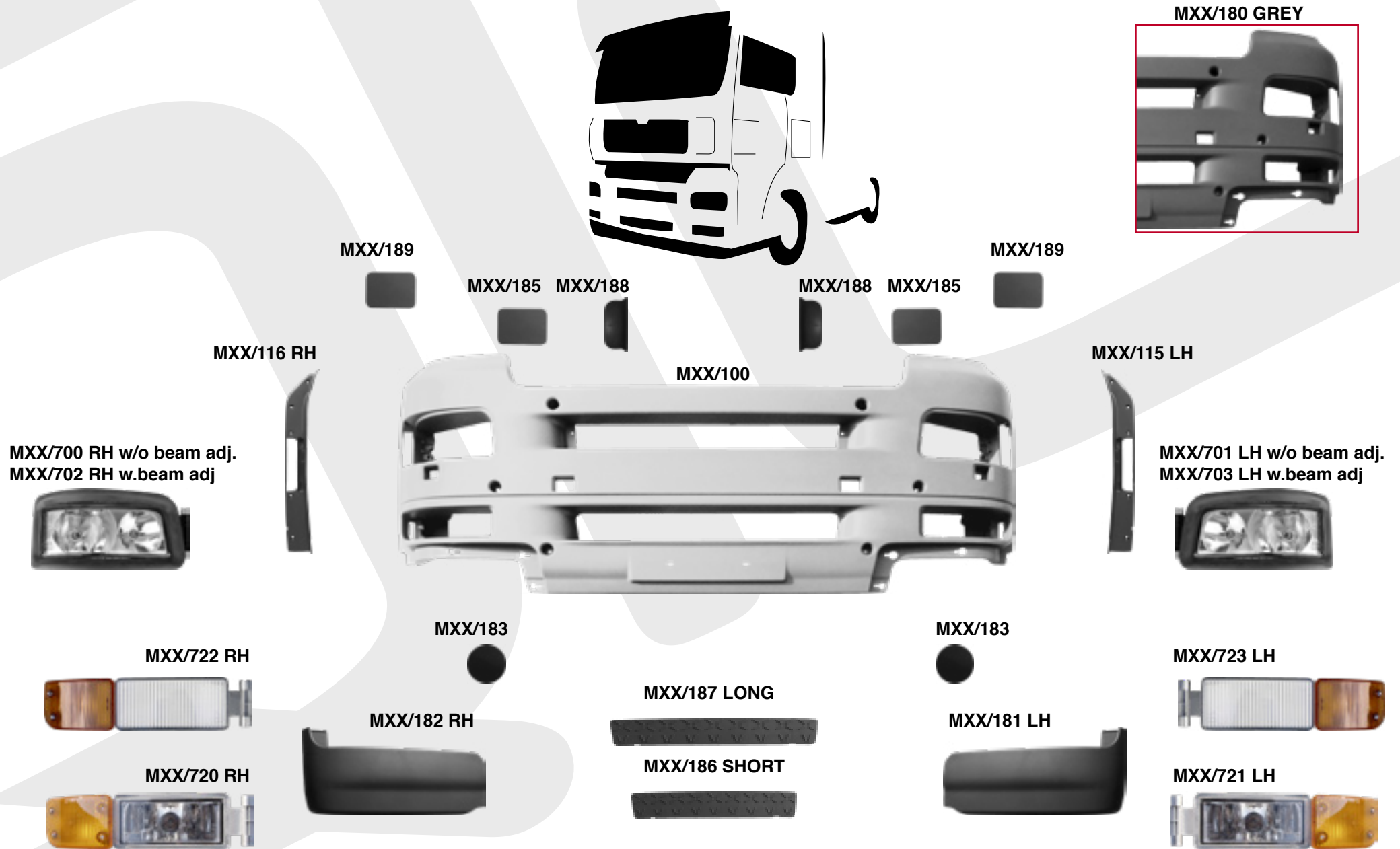

SUITABLE FOR **MAN TGA XL - XXL 2002**



MXX/260 RH



MXX/261 LH



MXX/201



MXX/262 RH



MXX/263 LH



MXX/264 RH



MXX/265 LH



MXX/200



MXX/216



MXX/217



SHINY CHROMED VERSION

SUITABLE FOR **MAN TGA XL - XXL 2002**



MXX/302 RH



MXX/303 LH



MXX/306 RH GREY



MXX/307 LH GREY



MXX/304 RH

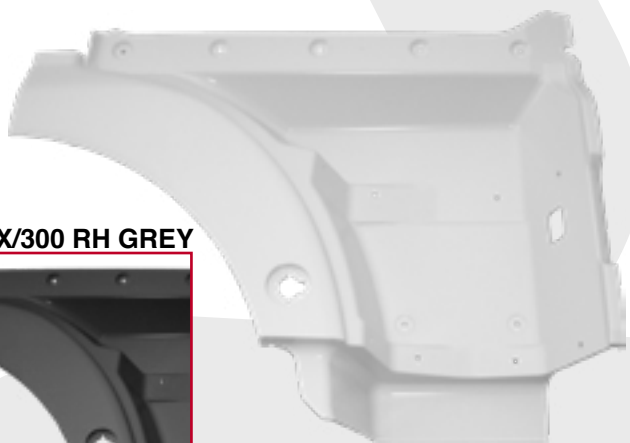

MXX/305 LH

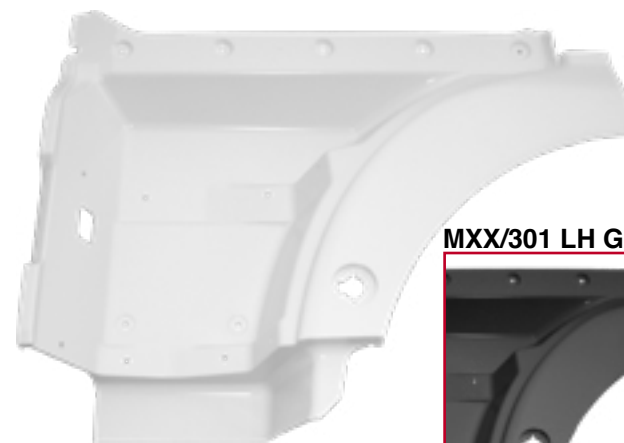

MXX/300 RH GREY



MXX/301 LH GREY



MXX/308 RH-LH



MXX/309 RH-LH

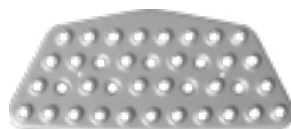

SUITABLE FOR **MAN TGA XL - XXL 2002**



MXX/355



MXX/350 RH *

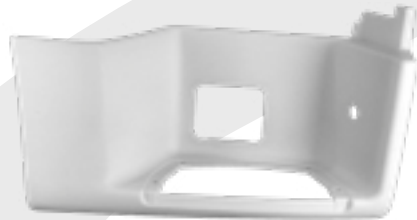

MXX/351 LH *

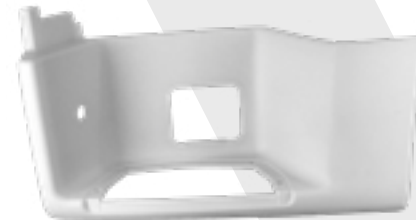

MXX/310 RH-LH



MXX/352 RH GREY **



MXX/353 LH GREY **



MXX/356



*** MXX/355 INCLUDED ** MXX/356 INCLUDED**

SUITABLE FOR **MAN TGA XL - XXL 2002**



MXX/370 RH



MXX/371 LH



MXX/362 RH



MXX/360 RH-LH



MXX/363 LH



SUITABLE FOR **MAN TGA XL - XXL / TGX / TGS**

MTX/400



MTX/415



MXX/400

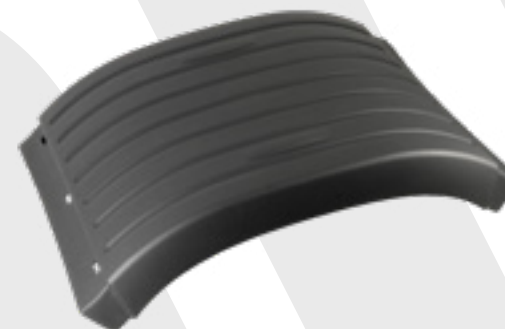

MXX/415



MTX/402 RH - LH *



MTX/402
REAR VIEW



MTX/445
H 95 cm

MXX/403 LH-RH FRONT/REAR



MTX/401 RH - LH *



MTX/475



* MTX/475 INCLUDED

SUITABLE FOR **MAN TGA M - L - LX 2002**



MML/180 GREY



MML/100



MML/116 RH



MML/115 LH



MML/182 RH



MML/186



MML/181 LH



SUITABLE FOR **MAN TGA M - L - LX 2002**



MTS/350 RH *



MTS/351 LH *



MML/356



MXX/310 RH-LH

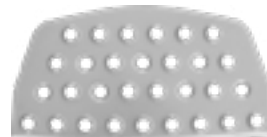

MML/350 RH **



MML/351 LH **



MML/355



*** MML/356 INCLUDED ** MML/355 INCLUDED**

SUITABLE FOR MAN F2000 1994

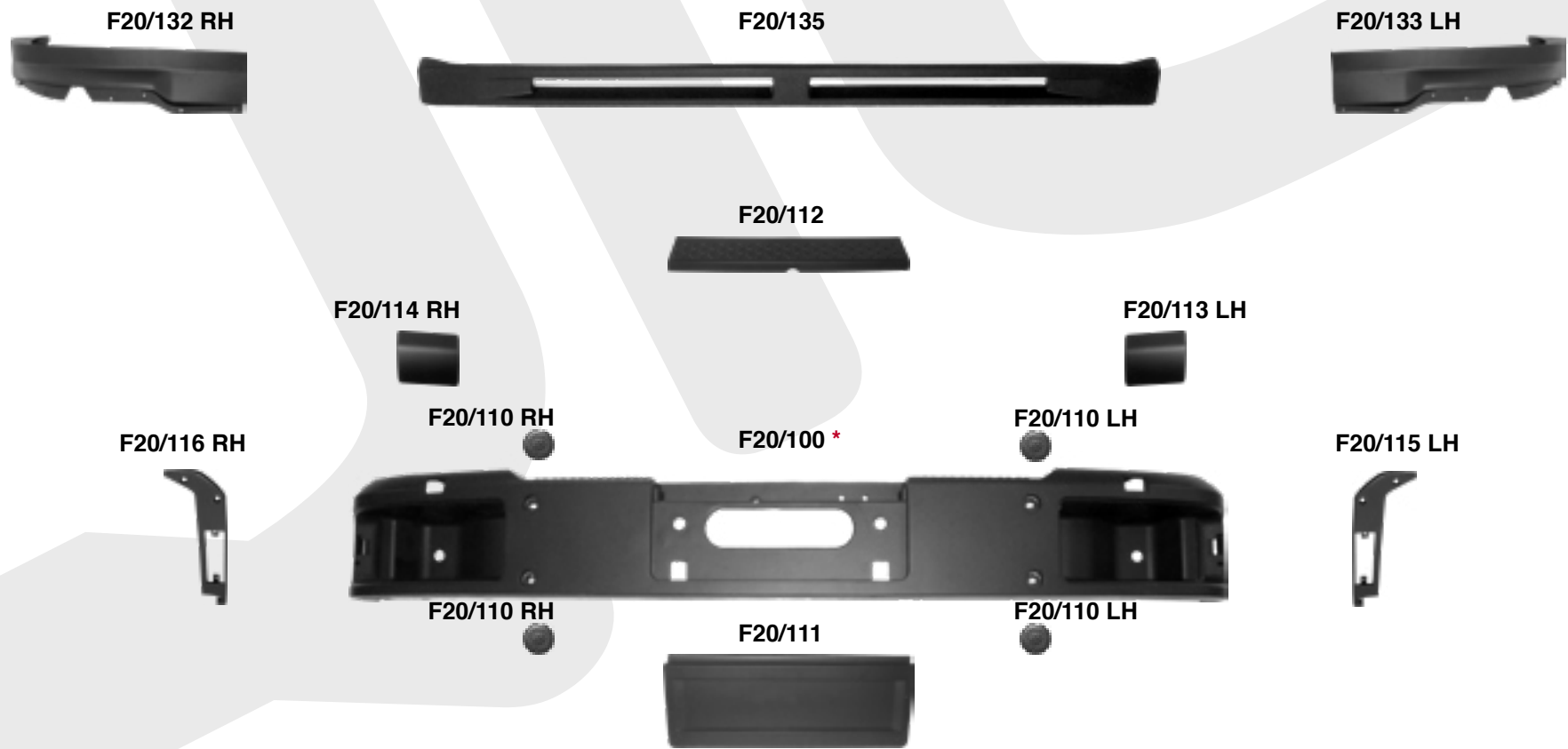

* F20/111 - 112 - 113 - 114 - 115 - 116 INCLUDED

SUITABLE FOR **MAN F2000 1994**

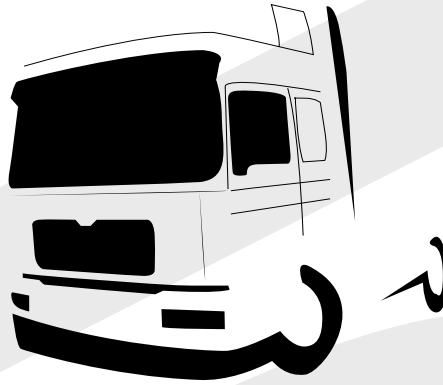

F20/105



F20/130



F20/146 RH

F20/104

F20/147 LH



F20/122 RH

F20/123 LH



F20/142 RH

F20/102

F20/143 LH



SUITABLE FOR MAN F2000 1994

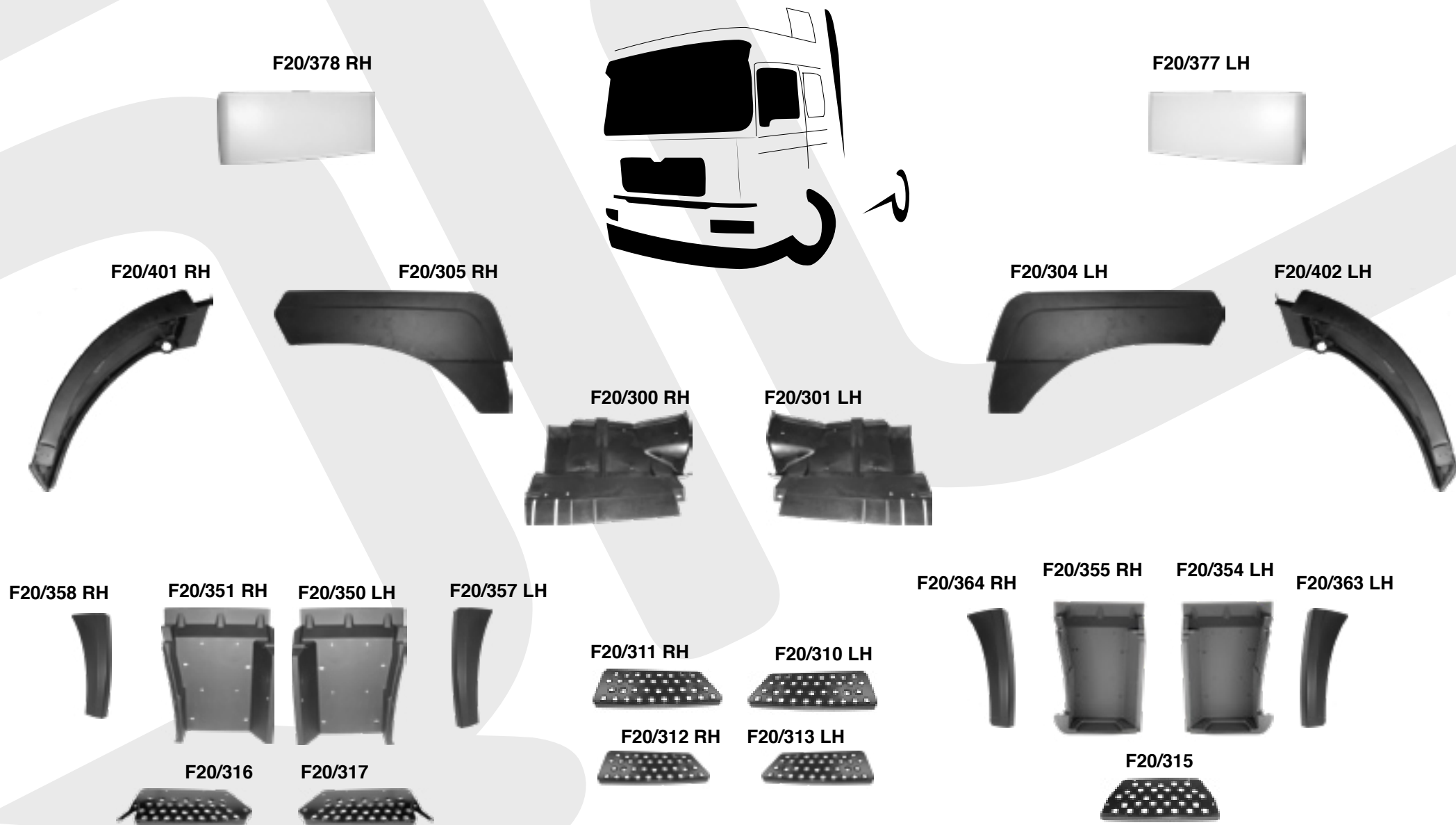

SUITABLE FOR MAN F2000 1994

F20/386 RH



BACK AND FRONT VIEW

F20/382 RH



F20/384 RH-LH



F20/371 RH-LH



set of two outer handles with keys

F20/369 LH



F20/381 RH



F20/399 LH

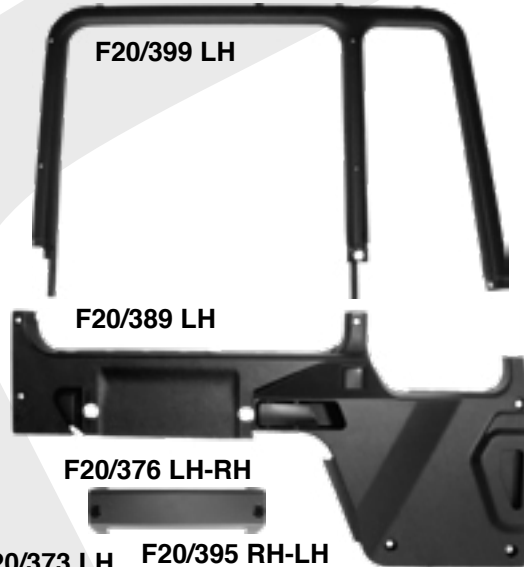

F20/389 LH

F20/376 LH-RH

F20/373 LH

F20/395 RH-LH



F20/398 RH

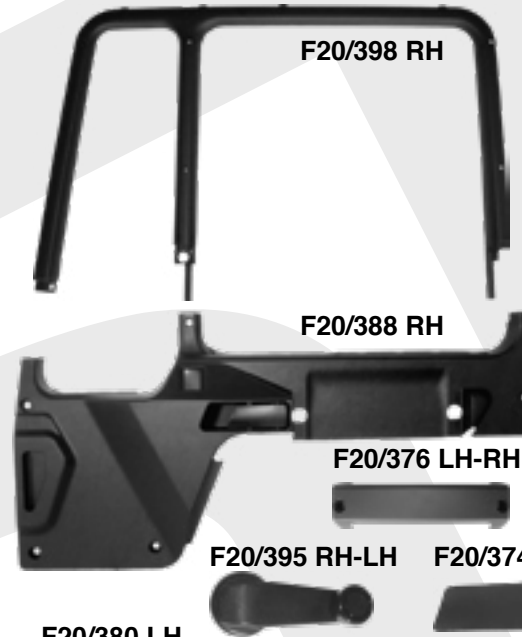

F20/388 RH

F20/376 LH-RH

F20/395 RH-LH

F20/374 RH

F20/380 LH



F20/368 RH



F20/385 LH



BACK AND FRONT VIEW

F20/383 LH



F20/384 RH-LH



SUITABLE FOR MAN F2000 1994

F20/262 RH



F20/260 RH



F20/205 RH



F20/500



F20/205 LH



F20/261 LH



F20/263 LH



F20/201



F20/CH6



F20/200

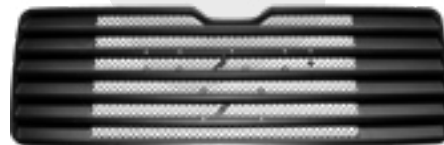

F20/CH2



F20/CH3



F20/CH5

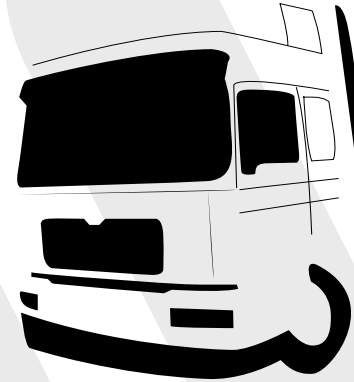

SUITABLE FOR **MAN TGL 2005**



MTL/300 RH



MTL/301 LH



MTL/100



MXX/310

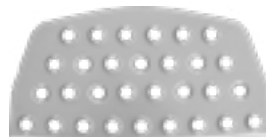

MML/186



SUITABLE FOR **MAN LE 2000 1992**



L20/300 RH



L20/301 LH



LE2/180





MAN TGX 2013

QTC	OEM	PAG
M6X/102	81416106754	3
M6X/102G	81416106774	3
M6X/103	81416106755	3
M6X/103G	81416106775	3
M6X/106	81416106750	3
M6X/106G	81416106770	3
M6X/107	81416106751	3
M6X/107G	81416106771	3
M6X/104	81416106752	4
M6X/104G	81416106772	4
M6X/105	81416106753	4
M6X/105G	81416106773	4
M6X/116	81416100532	4
M6X/116G	81416100532	4
M6X/117	81416100533	4
M6X/117G	81416100533	4
M6X/118	81416100575	4
M6X/119	81416100744	4
M6X/120	81976300196	4
M6X/122		4
M6X/122G		4
M6X/123		4
M6X/123G		4

MAN TGS 2013

QTC	OEM	PAG
M6S/102	81416106766	5
M6S/102G	81416106802 - 81416106804	5
M6S/103	81416106765	5
M6S/103G	81416106803 - 81416106805	5
M6S/104	81416106764	6
M6S/104G	81416106763	6
M6S/105	81416106800	6
M6S/105G	81416106801	6
M6S/106	81416106762	5
M6S/106G	81416106798	5
M6S/107	81416106761	5
M6S/107G	81416106799	5
M6X/116	81416100532	6
M6X/116G	81416100532	6
M6X/117	81416100533	6
M6X/117G	81416100533	6
M6X/118	81416100575	6
M6X/119	81416100744	6
M6X/120	81976300196	6

MAN TGX

QTC	OEM	PAG
MTX/100	81416100364	7
MTX/100K	81416100364-81416100369-81416100370	7
MTX/115	81416100369	7
MTX/116	81416100370	7
MTX/180	81416100363	7
MTX/180K	81416100363-81416100369-81416100370	7
MTX/181	81416140025	7
MTX/182	81416140026	7
MTX/300	81615100914	8
MTX/301	81615100913	8
MTX/304	81615100916	8
MTX/305	81615100915	8
MTX/309	81615100930	8
MTX/311	81615100929	8
MTX/706	81251016498	7
MTX/706X	81251016516	7
MTX/707	81251016499	7
MTX/707X	81251016515	7
MTX/710	81251100084	7
MTX/711	81251100083	7
MTX/722	81251016522	7
MTX/723	81251016521	7
MXX/183	81416850029	7

MAN TGS

QTC	OEM	PAG
MTS/181	81416140023	9
MTS/182	81416140024	9
MTS/350	81615100644	9
MTS/351	81615100643	9
MXX/356	81615100536	9

MAN TGA XL-XXL		
QTC	OEM	PAG
MXX/100	81416100305	10
MXX/115	81416100231	10
MXX/116	81416100232	10
MXX/180	81416100306	10
MXX/181	81416100227	10
MXX/182	81416100228	10
MXX/183	81416850029	10
MXX/185	81416850031 - 81416850056	10
MXX/186	81416102881	10
MXX/187	81416102882	10
MXX/188	81416850041	10
MXX/189	81416850040 - 81416850055	10
MXX/201	81611100053	11
MXX/216	81416850053	11
MXX/217	81416850061	11
MXX/260	81624100046	11
MXX/261	81624100047	11
MXX/262	81624100048	11
MXX/263	81624100049	11
MXX/264	81624400041	11
MXX/265	81624400039	11
MXX/300	81615100400-81615100280-81615100404	12
MXX/301	81615100399-81615100281-81615100403	12
MXX/302	81626100024	12
MXX/303	81626100023	12
MXX/304	81615100402 - 81615100706	12
MXX/305	81615100401 - 81615100705	12
MXX/306	81626100018	12
MXX/307	81626100019	12
MXX/308	81615100273	12
MXX/309	81615110001	12
MXX/310	81615105187	13
MXX/350	81615100374 - 81615100752	13
MXX/351	81615100333 - 81615100751	13
MXX/352	81615100372	13
MXX/353	81615100311	13
MXX/355	81615100538	13
MXX/356	81615100536	13

MAN TGA XL-XXL		
QTC	OEM	PAG
MXX/360	81612100462	14
MXX/362	81664100308	14
MXX/363	81664100309	14
MXX/370	81615100410	14
MXX/371	81615100411	14
MXX/400	81664106086	15
MXX/403	81664100293	15
MXX/415	81664100226	15
MXX/700	81251016448	10
MXX/701	81251016449	10
MXX/702	81251016450	10
MXX/703	81251016451	10
MXX/720	81253206112	10
MXX/721	81253206111	10
MXX/722	81253206090	10
MXX/723	81253206089	10
MTX/400	81664106606	15
MTX/401	81664106599	15
MTX/402	81664106625	15
MTX/415	81664400192	15
MTX/445	81664106674	15
MTX/475	81664400187	15

MAN TGA M-L-XL		
QTC	OEM	PAG
MML/100	81416100307	15
MML/115	81416100229	16
MML/116	81416100230	16
MML/180	81416100308	16
MML/181	81416100225	16
MML/182	81416100226	16
MML/186	81416102900	16
MML/350	81615100382 - 81615100740	17
MML/351	81615100355 - 81615100739	17
MML/355	81615100538 - 81615100822	17
MML/356	81615100823	17
MTS/350	81615100644	17
MTS/351	81615100643	17
MXX/310	81615105187	17

MAN F2000

QTC	OEM	PAG
F20/100	81416104114	18
F20/102	81416130073	19
F20/104	81416130071	19
F20/105	81416155061	19
F20/110	81960020425	18
F20/111	81416100150	18
F20/112	81416100191	18
F20/113	81416100159	18
F20/114	81416100158	18
F20/115	81416100151	18
F20/116	81416100152	18
F20/122	81416130066	19
F20/123	81416130069	19
F20/130	81416135035	19
F20/132	81416100166	18
F20/133	81416100167	18
F20/135	81416100164	18
F20/142	81416130078	19
F20/143	81416130079	19
F20/146	81416130080	19
F20/147	81416130081	19
F20/200	81611505060	22
F20/201	81611100043	22
F20/205	81748210095	22
F20/260	81624102224	22
F20/261	81624102225	22
F20/262	81624100064	22
F20/263	81624100063	22
F20/300	81612300066	20
F20/301	81612300067	20
F20/304	81612105363	20
F20/305	81612105364	20
F20/310	81615100267	20
F20/311	81615100268	20
F20/312	81615100262	20
F20/313	81615100263	20
F20/315	81615105181	20
F20/316	81615105196	20
F20/317	81615105197	20

MAN F2000

QTC	OEM	PAG
F20/350	81615100225	20
F20/351	81615100226	20
F20/354	81615100229	20
F20/355	81615100230	20
F20/357	81615105163	20
F20/358	81615105164	20
F20/363	81615105161	20
F20/364	81615105162	20
F20/368	81626406058	21
F20/369	81626406057	21
F20/371	81971006098	21
F20/373	81626410099	21
F20/374	81626410100	21
F20/376	81626410101	21
F20/377	81669120033	20
F20/378	81669120034	20
F20/380	81626004082	21
F20/381	81626004077	21
F20/382	81626806096	21
F20/383	81626806095	21
F20/384	81626800055	21
F20/385	81626806107	21
F20/386	81626806108	21
F20/388	81626306020	21
F20/389	81626306021	21
F20/395	81626416052	21
F20/398	81626300048	21
F20/399	81626300047	21
F20/401	81664100352	20
F20/402	81664100353	20
F20/500	81961210056	22
F20/CH2	81417015344	22
F20/CH3	81417015345	22
F20/CH5	81417226013	22
F20/CH6	81417226012	22

MAN TGL

QTC	OEM	PAG
MTL/100	81416100309 81416100352	23
MTL/300	81615100274 81615100820	23
MTL/301	81615100275 81615100821	23
MML/186	81416102900	23
MXX/310	81615105187	23

MAN LE2000

QTC	OEM	PAG
LE2/180	85416104032 85416104036	24
L20/300	85612100004	24
L20/301	85612100003	24



...you'll never drive alone

“I marchi utilizzati in questo catalogo sono proprietà dei fabbricanti dei veicoli industriali e commerciali a cui si riferiscono. Il loro utilizzo su questo catalogo serve unicamente per aiutare ad identificare il modello sul quale deve essere montato il pezzo di ricambio. I nostri articoli, pur non essendo originali, sono perfettamente intercambiabili ai veicoli a cui si riferiscono.”

“The property of the brand names used into this catalogue is exclusively of the makers. Original numbers used are for indication purpose only. Although our products are not original, they are perfectly interchangeable with them. “

“Les marques utilisées dans ce catalogue sont propriété des fabricants de véhicules industriels et commerciaux auxquels ils se réfèrent. Leur utilisation ne serve qu'à identifier le modèle sur lequel doit être montée la pièce de rechange. Nos articles, ne sont pas originaux, mais ils sont adaptables aux véhicules auxquels ils se rapportent “

“Die im vorliegenden Katalog verwendeten Marken sind Eigentum der Hersteller der Industrie- und Nutzfahrzeuge, auf die sie sich beziehen. Ihre Verwendung im vorliegenden Katalog dient ausschliesslich zur Identifizierung des Modells, in dem das Ersatzteil eingebaut werden soll. Unsere Artikel sind zwar keine Originalteile, aber dennoch perfekt austauschbar bei den Fahrzeuge, auf die sie sich beziehen “

“Znaki towarowe użyte w tym katalogu są własnością producentów pojazdów przemysłowych i użytkowych, do których się odnoszą. Numery OE w tym katalogu służą jedynie do właściwej identyfikacji części, oraz modelu w którym ta część zamienna może być zamontowana. Nasze artykuły, choć nie oryginalne, są doskonałe zamiennie z częściami oryginalnymi, do których się odnoszą “

“Τα εμπορικά σήματα που χρησιμοποιούνται σε αυτόν τον κατάλογο είναι ιδιοκτησία των κατασκευαστών των βιομηχανικών και εμπορικών οχημάτων στα οποία αναφέρονται. Η χρήση τους σε αυτόν τον κατάλογο χρησιμεύει μόνο για να βοηθήσει στον προσδιορισμό του μοντέλου στο οποίο πρέπει να montantato το ανταλλακτικό. Τα άρθρα μας, αν και δεν είναι πρωτότυπα, είναι απολύτως ανταλλάξιμα με τα οχήματα στα οποία αναφέρονται. “

“A propriedades das marcas usadas neste catálogo é dos fabricantes dos veículos. Codigos originais são usados apenas para indicação aos nossos clientes. Nossos produtos não são originais, mas perfeitamente intercambiáveis “

“Las marcas especificadas en este catalogo son propiedad de los fabricantes de vehículos industriales y comerciales referidos. El propósito de este catalogo es único y exclusivamente, para identificar el modelo en el cual se monta la pieza de ricambio suministrada por nosotros. Las referencias originales son utilizadas única y exclusivamente para su identificación por parte de nuestros clientes. Nuestros artículos no son originales pero perfectamente intercambiables“